

Article number: 201581M1025PLE

Description: E+G Screw GN 1581-M10-25-PL-E
EPDM Sealing ring in hygienic design

Measures

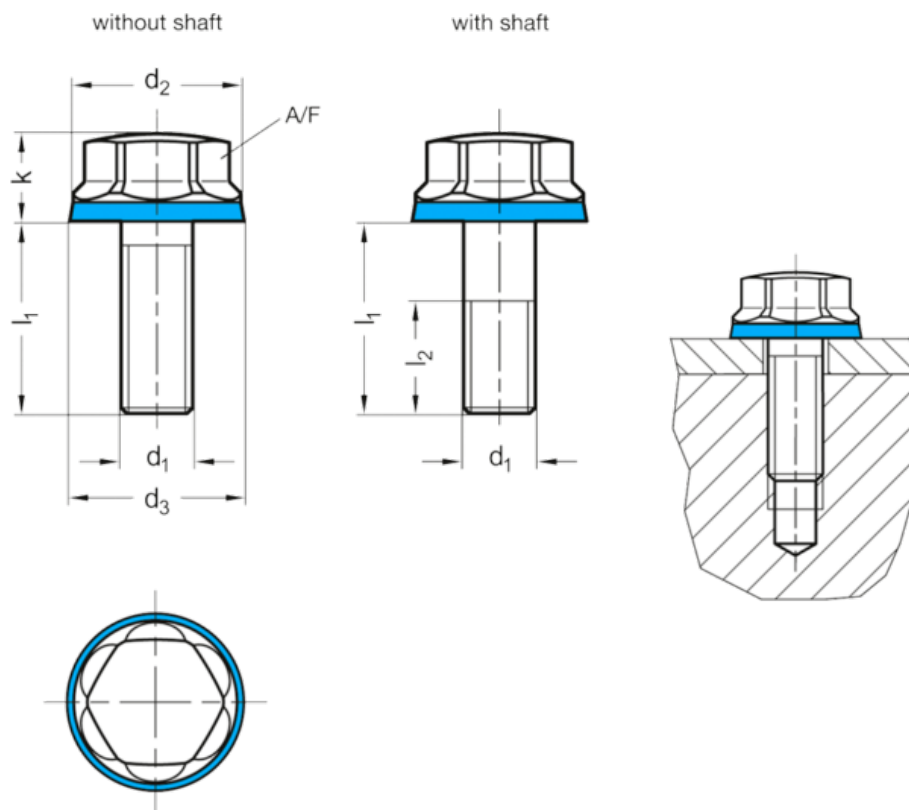

A/F	= 16	Weight in (g) = 31
d1	= M10	
d2	= 19	
d3	= 19.8	
l1 without shaft	= 25	
l1 with shaft	= -	
l2	= -	
k	= 9.5	